

FORMENTA SANDBEHÅLLARE

Monteringsanvisning - 350L & 550L

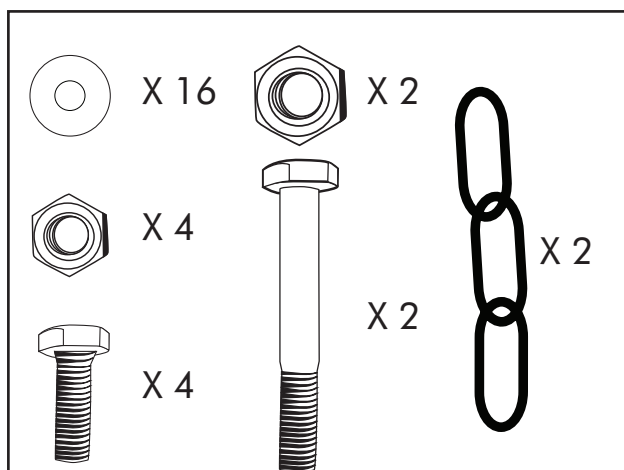
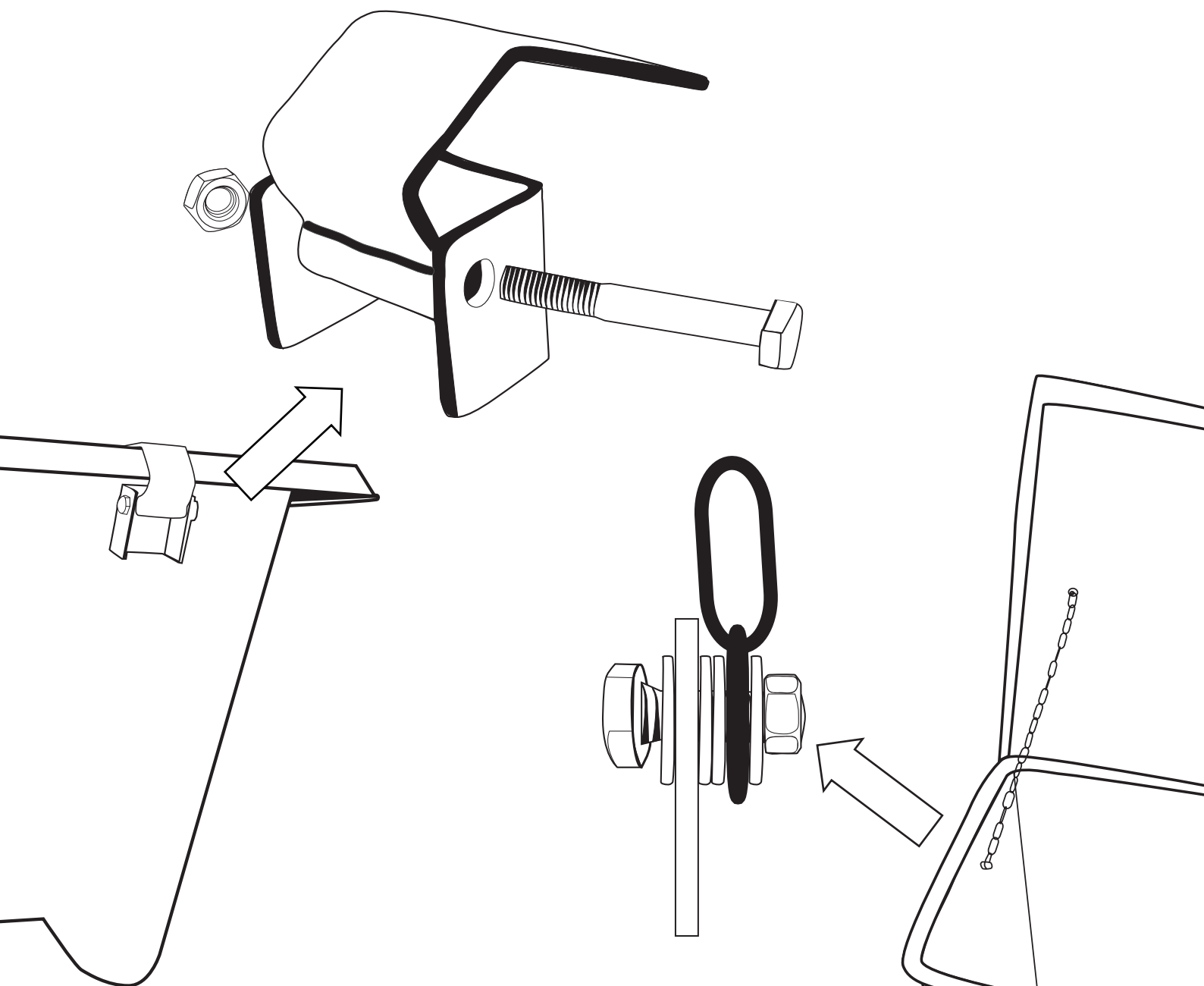

Box 525, 331 25 Värnamo
Telefon: 0370 692550 | Fax: 0370 49128
info@formenta.se | www.formenta.se